

The background image shows an outdoor seating area with several dark wooden picnic tables. A tall, silver metal patio heater with a black base and a glass-enclosed burner is positioned in the foreground. The setting is outdoors against a red brick wall with a large arched window in the background.

Code of Practice for the safe use of LP Gas at public events in Victoria

Creating a safer state
with electricity and gas

**This Code of Practice has been developed
with the assistance of:**



Introduction

This Code of Practice is a set of guidelines that applies to the use of Liquefied Petroleum Gas (LP Gas) at public events. Public events may be defined as outdoor events that include:

- » **sporting events**
- » **entertainment events**
- » **festivals**
- » **school fetes**
- » **church fetes**
- » **local markets**
- » **other non-profit group functions.**

These guidelines will ensure an acceptable level of gas safety and minimise the possibility of gas-related incidents.

Organisers of public events have a duty of care to provide a safe operational environment.

WorkSafe Victoria, in its Advice for managing major events safely 2006, states:

Event organisers have a duty of care under the *Victorian Occupational Health and Safety Act 2004* (the OHS Act) to provide a safe operational environment. Under this legislation, event organisers must ensure so far as reasonably practicable that: people are not exposed to risks arising from the operation; and any place where employees and self-employed persons work is safe. The definition of this duty is broad. Proactive attention by event organisers may be achieved by a process of identification, assessment and control of safety risks. In some circumstances, there may be several parties who owe a concurrent duty of care. It is important that safety is comprehensively managed and communicated by and between all relevant duty holders.

Refer to the WorkSafe Victoria website worksafe.vic.gov.au for a copy of the event planning and risk management information document Advice for managing major events safely 2006.

This Code of Practice should be read in conjunction with AS/NZS 1596 The storage and handling of LP Gas, AS/NZS 5601 Parts 1 and 2 Gas installations and WorkSafe's Advice for managing major events safely and all relevant codes within.

This Code of Practice has been developed with the assistance of:

- » Energy Safe Victoria (ESV)
- » WorkSafe Victoria
- » Country Fire Authority (CFA)
- » Fire Rescue Victoria (FRV)
- » Gas Energy Australia
- » Elgas Ltd
- » Kleenheat Gas Pty Ltd
- » Origin Ltd
- » Supagas Pty Ltd
- » United Gas Pty Ltd
- » Australian Gas Association (AGA)

Attendees at document review session:

- » Harry the Hirer Pty Ltd
- » Melbourne 2010 Cycling
- » Melbourne City Council
- » Melbourne Racing Club
- » Safe Not Sorry Pty Ltd
- » Spotless Group Ltd
- » THA Consulting
- » Transplumb Pty Ltd

Written Submission and Comments by:

- » Australian Grand Prix Corporation
- » Victoria Racing Club Ltd

Revised October 2020.

Revision

This code of practice was reviewed and updated in October 2020 to reflect amendments to standards and regulations over time as well as general updates to improve clarity and readability.

Significant updates to this document include the following:

- a) General rewording and reordering text to improve clarity.
- b) Clarification of requirements for record-keeping.
- c) Further detail provided on emergency planning and implementation of plan.
- d) Additional requirements on the checking of leaks and soft seals at cylinder connections.
- e) Requirements for LP Gas storage and delivery and cylinder location expanded and clarified.
- f) Ventilation requirements made consistent with AS/NZS 5601.1.
- g) Indoor gas cylinder storage limits for assembly halls greater than 200m² reduced to 180kg total to align with AS/NZS 1596-2014.
- h) Appendix B revised to reflect the Victorian Dangerous Goods (Storage and Handling) Regulations 2012.

Introduction	1
Revision	3
Definitions	8
Appliances	8
Outdoor appliance	8
Indoor appliance	8
Certified appliance	8
Cartridge-operated appliance	8
Building structures	8
Permanent structures	8
Outdoor temporary structures	8
Indoor area structures	9
Outdoor appliance location	9
Compliance plate	12
Mobile catering vehicles and relocatable kitchens	12
Risk assessment	12
Documentation and notification	13
Procedures	13
Training records	13
Risk assessment documentation	13
Records of inspections by event organisers	13
Records of regulatory inspections and approvals	13
Design, implementation and operation documentation	14

Responsibilities	15
Event organiser	15
Appliance hirer	15
Authorised person	16
Catering vendor	16
Gas supplier	17
Energy Safe Victoria	17
WorkSafe Victoria	17
Fire Rescue Victoria (FRV) and the Country Fire Authority (CFA)	17
Risks	18
Storage	18
Cylinder handling	18
LP Gas leakage	18
Emergency planning	19
Developing an emergency plan	19
Fire protection	19
Fire extinguishers	19

Gas appliance requirements	20
Gas leaks	20
Certified appliances	20
Domestic appliances	20
Safety devices	20
Appliance conversion	20
Appliance location	22
Clearance from combustible materials	22
Maximum operating pressure	22
Specific LP Gas appliance requirements	22
Hot water units	22
Heaters	22
Ring burners and portable wok burner appliances	23
Solid plate barbecues	23
Appliance ventilation	23
Cylinders and components	25
LP Gas delivery and storage	25
Cylinder delivery (cylinder loading and unloading areas)	25
Cylinder storage	25
Minimising LP Gas storage and usage	26
Cylinders in use	26
Decanting	26

Connection and changeover	26
Minimisation of changeovers	26
Movement of appliances or cylinders while connected or in operation	27
Turn off at the cylinder	27
Stabilisation of cylinders	27
Distance from an ignition source	28
Walkways and egress routes	28
Ventilation	28
Regulators	29
Gas hoses	30
Setting up and dismantling	30
Gas limits	31
General	31
Permanent structure with permanent LP Gas installation	31
Appendix A—Example Gas Safety Check List	35
Check List	35
Appendix B—Victorian Dangerous Goods (Storage and Handling) Regulations	37
Placarding	37
Preparation of a manifest	37
Notification of storage and handling (Regulation 66)	37
Emergency services written advice	38
Notes	39

Definitions

Appliances

All gas appliances should be certified and fit for purpose for use at public events. Fixed gas appliances and pipework must only be installed by an authorised person such as a licensed/registered plumber and gasfitter. Such persons must submit a start work and compliance notice to ESV and should produce their registration/licence on request.

Outdoor appliance

An outdoor appliance is designed for use outdoors. It relies on open air and natural ventilation to disperse gas leakage and combustion products. A gas appliance designed for outdoor installation must be used externally.

Indoor appliance

An indoor gas appliance is designed for indoor installation; it may be installed externally in a quasi-outdoor situation.

Quasi-outdoor—An outdoor area sufficiently weatherproofed to allow the installation of an appliance certified for indoors without affecting its safety, combustion or integrity.

Certified appliance

A gas burning appliance is certified when the appliance has been assessed by:

- » a body accepted by ESV
- » an independent certifying body recognised by ESV, such as the AGA, SAI Global, IAPMO or Global-Mark
- » ESV

and has a certificate number to demonstrate compliance with a Standard.

Cartridge-operated appliance

These gas appliances are not approved for use at public events. These appliances are commonly used in domestic situations and are fuelled by a disposable butane gas cartridge.

Building structures

Permanent structures

A permanent structure is a building, such as a hall, pavilion or assembly building used for an event and includes churches, schools and sporting club halls. Carport-type structures, gazebos and rotundas are also considered permanent structures.

Outdoor temporary structures

Outdoor temporary structures include marquees, tents, booths, awnings or a structure with two sides open or one side open (equal to 25 per cent of the total wall area) and 30 per cent of the remaining total wall area open and unrestricted. Refer to Figure 1: Examples of outdoor areas acceptable for the use of LP Gas.

Note: A marquee, tent or booth set up in the interior section of a building would be classed as indoors.

Outdoor appliances may be located outdoors, or be installed in the interior of structures meeting the requirements of Figure 1. Cylinders may be located in the interior of marquees, tents or booths if they comply with the requirements of Table 1: LP Gas allowable quantity and cylinder sizes.

Indoor appliances may be located in the interior of outdoor temporary structures when supplied with adequate ventilation.

Where temporary structures are grouped together, e.g. a group of marquees, stalls or tents at a market, there shall be a maximum of 10 such structures using LP Gas in any such group.

Groups of temporary structures using LP Gas shall be separated by at least 15m. The intervening space may be occupied by temporary structures in which no flammable gas or flammable liquids are kept. Refer to Figure 5: Description of separation distances between groups.

Indoor area structures

A marquee, tent or booth set up in the interior section of a building would be classed as indoors. Outdoor appliances may be located in the interior of structures, subject to the approval of ESV and supplied with adequate ventilation.

Outdoor appliance location

Outdoor appliances may be located outdoors, or be installed in the interior of structures meeting the requirements of the following drawings. Cylinders may be located in the interior of marquees, tents or booths if they comply with the requirements of Table 1: LP Gas allowable quantities and cylinder sizes.

Figure 1: Examples of outdoor areas acceptable for the use of LP Gas

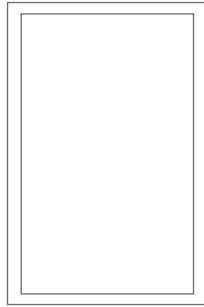
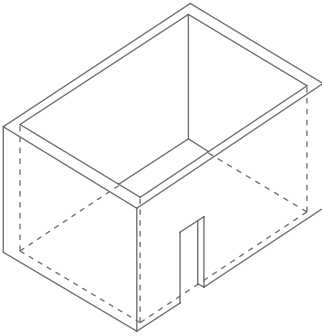

Enclosure with walls on all sides, but at least one permanent opening at ground level and no overhead cover.

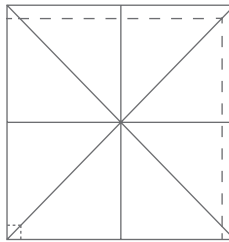
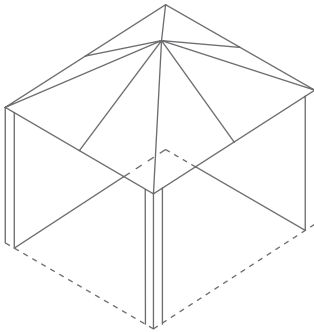

Outdoor area.
Two adjacent sides open.



All gas appliances should be certified and fit for purpose for use at public events.

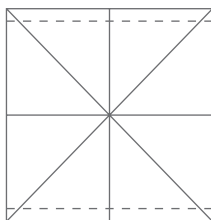
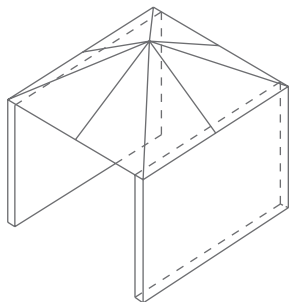

Outdoor area.
Both ends open.

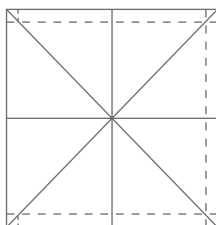
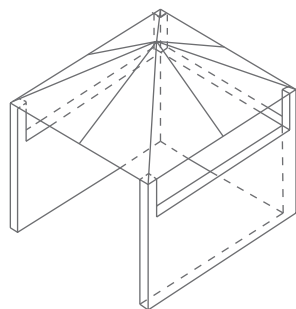

Outdoor area. Open side
at least 25 per cent of the
total wall area and 30 per
cent or more in total of the
remaining wall area is open
and unrestricted.

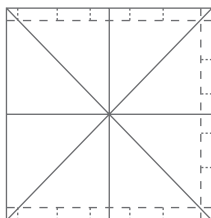
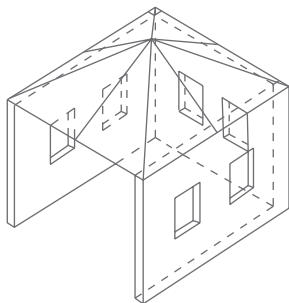

Outdoor area. Open side
at least 25 per cent of the
total wall area and 30 per
cent or more in total of the
remaining wall area is open
and unrestricted.

Extract from AS/NZS 5601
reproduced with permission
from SAI Global under
Licence 1408-c040.

Compliance plate

A compliance plate is a plate that identifies a mobile catering vehicle or a relocatable kitchen as meeting the required safety standards. Compliance plates issued by ESV or recognised by ESV must be securely fixed and placed in an accessible location on mobile catering vehicles or relocatable kitchens. If compliance plates are not fitted event organisers must not allow vehicles to operate at an event.

Mobile catering vehicles and relocatable kitchens

These vehicles and relocatable kitchens in which LP Gas is used to prepare food or provide hot water shall be fitted with a fire blanket and a suitable portable extinguisher. They shall display either an ESV compliance plate or an interstate equivalent compliance plate.

Mobile catering vehicles are defined as:

- » Trailers and converted caravans
 - » generally have one or two gas appliances installed for a specialist vendor
 - » may have appliances open to atmosphere (trailers), or they may be enclosed with integral appliances
 - » generally have gas supplied from 9kg cylinders.

- » Self-propelled vehicles
 - » generally have one or two fixed appliances installed internally
 - » are generally supplied with gas from 45kg cylinders that are attached to the vehicle
 - » sometimes use gas cylinders delivered to site.
- » Large semi-trailers
 - » are generally fully self-contained with a number of fixed appliances such as deep fryers and solid top grillers
 - » are generally supplied with gas from 45kg cylinders separately delivered to site
 - » may be manufactured with slide-out sides.

Relocatable kitchens, which are transported from event to event, also fall under the umbrella of mobile catering.

- » Relocatable kitchens
 - » are generally kitchens within a converted shipping container
 - » are transported from event to event
 - » may be used at events, building sites, roadside locations or mining sites.

Risk assessment

Risk assessment is a systematic approach to identify hazards, assessing their risk and determining the controls to minimise risk at the event. Completing the checklist at the back of this Code of Practice will assist with the risk assessment for each vendor.

Documentation and notification

Throughout these guidelines, reference will be made to procedures, records and other forms of documentation that would be considered critical to the safe operation of LP Gas at public events. These documents shall:

- » provide a clear and consistent understanding of the decision-making process
- » give concise information to those instructing others in safe work practices
- » provide records of incidents, actions taken and the follow up to the incident.

Procedures

Event organisers must ensure there are documented procedures in place for the safe use of LP Gas at public events. These procedures should include:

- » storage and handling of cylinders when they are not in use
- » cylinder connection and changeover
- » leak testing
- » lighting of appliances
- » turning off appliances
- » emergency equipment procedures
- » emergency management plans.

Procedures for safe work practices must be developed for all tasks, particularly those involving some inherent safety risk, and all personnel carrying out these tasks must be adequately trained.

Training records

In addition to the procedures, event organisers must keep training records to demonstrate that all those persons required to undertake a particular task have received adequate training.

Risk assessment documentation

Results of risk assessments carried out by the event organiser shall be kept on site as a record should any changes occur, or to address any concerns raised by regulatory or other personnel.

Records of inspections by event organisers

Inspections and actions taken by event organisers must be recorded. Records must be kept for a minimum of three months after the date of the event. To assist with continuity and risk management, it is recommended that all documentation be available for the next event where possible.

Records of regulatory inspections and approvals

During the event it is likely that different regulatory authorities, such as ESV, WorkSafe Victoria, FRV and CFA, may conduct inspections. Where improvements or changes are requested, the completion of these tasks must be noted and kept as a record for a minimum of three months. To assist with continuity and risk management, it is recommended that all documentation be available for the next event where possible.

Design, implementation and operation documentation

Documents concerning the design, implementation and operation of the event include:

- » kitchen design layouts, including the location of appliances and quantity of LP Gas
- » emergency service or regulatory authority notifications
- » equipment provider maintenance or inspection records or a signed statement from the appliance hirer that such records for all equipment are held at his premises
- » photographs or other visual documentary evidence.

These documents shall be kept for a minimum of three months to demonstrate due diligence by the event organiser. To assist with continuity and risk management, it is recommended that all documentation be available for the next event where possible.

Responsibilities

Event organiser

The event organiser has the overall responsibility for the Safety Management System for the safe operation and use of LP Gas at an event. The event organiser is responsible for:

- » carrying out regular inspections of the operations and facilities prior to and during the event
- » ensuring a suitably competent and experienced person is available to oversee all LP Gas activities including the lighting and extinguishing of appliances. Personnel operating an appliance shall be trained in its safe operation, including fire extinguisher training
- » ensuring the risk assessment and documentation is completed and retained
- » ensuring that records and safety arrangements of gas installations shall be prepared and retained by their operators including the site Gas Safety Check List (Refer to Appendix A)
- » ensuring the requirements under the Victorian Dangerous Goods (Storage and Handling) Regulations are complied with, including, if necessary:
 - » placarding
 - » preparation of a manifest
 - » seeking a fire protection report and notification (refer to Appendix B Regulatory storage Levels requiring Action under the Victorian Dangerous Goods (Storage and Handling) Regulations.
- » ensuring that catering vendors meet their obligations for safe use of LP Gas
- » ensuring that storage and handling of LP Gas is correctly managed, including provision of safety standards, safety procedures and emergency procedures
- » liaising with fire services, regulatory authorities, gas companies, catering vendors and appliance equipment hirers. The event organiser should be aware that where formal advice is required it may take some time for provision of the advice
- » ensuring all mobile catering vehicles and relocatable kitchens are fitted with compliance plates.

Appliance hirer

The appliance hirer who owns and hires out appliances, equipment and LP Gas cylinders shall ensure that:

- » all appliances available for hire are certified
- » appliances shall be suitable for use in a commercial environment
- » appliances are in good working order and condition when supplied
- » details of maintenance and inspection relating to individual appliances can be made available upon request
- » assistance is given to the catering vendor in the development of safe procedures for all equipment and LP Gas cylinders.

Authorised person

The authorised person is the person who has been licensed or registered by the Victorian Building Authority (VBA) to carry out gasfitting work and to ensure gas work meets relevant standards and is left safe to use. The person may include an individual or a company.

The person carrying out gasfitting work on a gas installation must report any gas incident to ESV and to the LP Gas supplier.

If the person carrying out gasfitting work on a gas installation becomes aware of a danger arising from a defect in the gas installation, the person must without delay make the installation safe and notify the owner of the installation of the defect.

The authorised person shall ensure gasfitting notices are issued for LP Gas installations as required.

Catering vendor

The catering vendor (the person in charge of a vendor site) shall designate a suitably competent and experienced person to be responsible for the safe use of LP Gas for the period over which their catering services are provided at the event.

That person shall ensure that:

- » A plan of their catering facility is prepared, including:
 - » the types and numbers of catering equipment
 - » the positioning and arrangements of the equipment
 - » gas supply.
- » This is to be supplied to the event organiser for inclusion in the site's emergency management plan.
- » The necessary clearances and separations, venting and air supply, and fire fighting equipment are maintained. Refer to Clearance from combustible materials later in this document.
- » Catering staff are instructed and competent in LP Gas safety procedures, including:
 - » the connecting and changing over of gas cylinders
 - » storage of unused and used cylinders
 - » shutting off appliances when not in use
 - » keeping records.
- » Appliances used are installed safely including verification from the supplier that the appliances are fit for purpose and properly maintained.
- » Only certified appliances are used. If appliances are owned by the catering vendor, records of maintenance and inspection are updated and kept for each appliance.

- » All catering site personnel are instructed in the emergency management plan and can implement it.
- » A check list (see Appendix A) shall be completed prior to the commencement of the event and passed to the event organiser.

While some catering vendors will own equipment, many will also hire LP Gas appliances and cylinders. Regardless of the responsibilities of the appliance hirers, the catering vendor shall also carry out inspections of the LP Gas equipment to ensure that no damage has been caused during its installation or use. These inspections shall be carried out prior to the first use of equipment, and on a daily basis prior to commencement of operations.

Catering vendors are also reminded that cartridge-operated gas appliances are not approved for use at public events and the practice of decanting LP Gas from one cylinder to another should not be carried out.

Gas supplier

The LP Gas supplier shall ensure that:

- » Cylinders are delivered in a safe manner, to a safe and complying location. Refer to the LP Gas delivery and storage section of this document.
- » Cylinders, valves and connections are fit for purpose and in good working condition.

Energy Safe Victoria

ESV oversees the safe use of gas appliances at public events, specifically their installation and connection to LP Gas cylinders. ESV inspectors may attend the event prior to its start or during the event. If any unsafe or non-complying situation is found, the event organiser shall be notified to take appropriate action. ESV inspectors may liaise with WorkSafe Victoria and fire authorities on gas safety matters.

WorkSafe Victoria

WorkSafe Victoria regulates all workplace OH&S related matters including the storage and handling of LP Gas cylinders (when not connected to an appliance). This includes OH&S matters at public events. WorkSafe Victoria inspectors may liaise with ESV and fire authorities on gas safety matters.

Fire Rescue Victoria (FRV) and the Country Fire Authority (CFA)

These Victorian fire authorities can provide advice on preparing emergency plans and on fire protection equipment. Fire safety officers may liaise with ESV and WorkSafe Victoria on gas safety matters. (Refer to the Emergency Planning section of this document).

Risks

Storage

LP Gas is stored under high pressure in cylinders. Due to the amount of energy stored in a cylinder, care must be taken to minimise the quantity of gas in use or in storage at public events. See Appendix B for regulatory storage levels. Refer to the Victorian Dangerous Goods (Storage and Handling) Regulations and AS/NZS 1596 The storage and handling of LP Gas for permissible storage quantities.

Cylinder handling

LP Gas cylinders are often heavy and awkward to handle. This should be considered in the safe manual handling of cylinders at all times and referenced in the event risk assessment.

LP Gas leakage

Leakage of LP Gas is a risk as it is heavier than air. It will accumulate at low levels within a structure or facility and is slow to disperse.

Emergency planning

Developing an emergency plan

While all steps should be taken to avoid the risk of an incident occurring, it is important that planning for any emergency situation be formalised. An emergency plan is a written document detailing how a site or facility and its occupants will manage an emergency.

An effective emergency plan consists of the preparedness, response and recovery activities and includes the agreed emergency management roles, responsibilities, strategies and system arrangements of the site.

The level of detail in the emergency plan will depend on the complexity of the risks on site. Additional information can be obtained from the FRV at frv.vic.gov.au or CFA at cfa.vic.gov.au.

In the event of an emergency occurring, the appropriate emergency services should be immediately contacted on 000.

Fire protection

The first response in any emergency situation is to attempt to minimise the threat to life and property.

Adequate and appropriate fire protection equipment should be available in any catering operation.

Where LP Gas is to be used and other combustible materials are in the vicinity, it is imperative that fire extinguishers and fire blankets are available and positioned in a manner that will allow access to them in the event of a fire.

It is important to ensure that all personnel who may be required to use fire protection equipment, such as fire extinguishers and blankets, be correctly trained in their safe use.

In the case of a fire or smoke developing it is recommended that the emergency plan be activated immediately. If the fire cannot be extinguished safely and quickly, it is recommended that all persons should evacuate the area and that emergency services be contacted on 000.

Fire extinguishers

It is recommended that dry chemical fire extinguishers, type 2A60B(E), be available for use on LP Gas fires.

Gas appliance requirements

The catering vendor must ensure all gas appliances used at public events are certified, in good condition and have the operating instructions fastened to the appliance, or a manual or procedure available. Appliances should not be modified.

Gas leaks

Cylinders and their fittings shall be inspected for leaks prior to their use by using a soapy water or detergent solution to detect leaks at all joints. O-rings and soft seals shall be free of damage and defects, and shall be compatible and suitable for the gas being conveyed, the pressure to which they will be subjected and the environment in which they will be installed.

Certified appliances

All gas appliances shall be certified and display their approval badge as proof of certification. See Figure 2. If it cannot be proved that the appliance is certified then it shall not be used at a public event. It is a breach of the Victorian Gas Safety (Gas Installation) Regulations to connect an LP Gas cylinder to a gas appliance that has not been certified.

If an appliance does not display an approval badge, ESV should be contacted and an arrangement made to determine the appliance's suitability before the public event commences.

A national database of certified gas appliances and components can now be accessed via the Gas Technical Regulators website gtrc.gov.au.

Domestic appliances

It is strongly recommended that domestic gas appliances are not used in commercial applications at public events due to their lighter construction, which can render them unsuitable for continuous use and increase the risk of failure of components and safety devices.

Safety devices

Safety devices fitted to gas appliances shall not be interfered with or removed. These safety devices may include flame safeguard systems, thermostats, over temperature cut-offs and excess flow valves.

Appliance conversion

All appliances converted from another gas or fuel type to LP Gas must show proof of certification. This work must be carried out by an authorised person.

Figure 2: Examples of appliance approval badges and compliance plates

AGA



Global-Mark



IAPMO



SAI Global



BSI



Energy Safe Victoria



Appliance location

Gas appliances shall be located so that they:

- » are correctly ventilated and flued to ensure proper operation
- » receive an adequate air supply to allow complete combustion of LP Gas
- » are suitably protected against the effects of corrosive and physical damage
- » permit functional adjustment, safe ignition, access for operation and maintenance
- » avoid undue restriction of the movement of persons.

A gas appliance shall be installed only in a location or on a table or bench capable of supporting the weight of the gas appliance. All gas appliances shall be approved or certified and be fit for purpose for use at public events.

A gas appliance shall not be installed:

- » internally, unless it is designed for indoor installation
- » externally, unless it is designed for outdoor installation. However, an indoor gas appliance may be installed externally in a quasi-outdoor situation.

Note: Outdoor LP Gas appliances shall not be used in marquees, tents or booths unless the marquees, tents or booths meet the criteria for an outdoor temporary structure. Refer to Figure 1 for examples of temporary outdoor structures.

Clearance from combustible materials

Appliances shall be installed with the clearance distances from combustible materials (including walls, canvas, curtains etc.) as shown in Figure 3.

Maximum operating pressure

The maximum operating pressure supplied to any appliance shall not exceed 3kPa unless otherwise approved by ESV.

Specific LP Gas appliance requirements

Gas appliances shall be installed in accordance with the manufacturer's instructions. Where there is any conflict between the manufacturer's instructions and the requirements of this document, the matter shall be referred to ESV for a ruling.

Hot water units

All hot water units shall be installed in a location or on a table or bench capable of supporting the weight of the hot water unit when fully laden.

Heaters

Portable gas heaters that are certified for outdoor use shall not be used indoors.

Ring burners and portable wok burner appliances

Ring burners or portable wok burners shall be installed in accordance with the manufacturer's instructions. They shall be secured to prevent movement and shall be placed on a non-combustible surface unless approved otherwise by the appliance manufacturer. They are designed for outdoor use only and must be operated away from any combustible materials or surfaces.

The ring burner or wok burner must be used on a sturdy, stable, level, flat surface, capable of supporting the weight of the gas appliance and protected from direct drafts and in a well-ventilated location. Ring burners and portable wok burners are not accepted at events unless the burner is certified with an integral pan support.

Ring burners should be used in an above-ground, open air situation with natural ventilation, without stagnant areas, where any gas leakage is rapidly dispersed by wind and natural convection.

Where a ring burner or wok burner is installed on a combustible surface the surface shall be protected by fire-resistant material. The protection is to extend at least 50mm beyond the perimeter of the appliance and is to be made impervious to cooking fats.

Solid plate barbecues

A solid plate barbecue, certified for outdoor use, may be located in a well-ventilated, indoor location at public events.

Appliance ventilation

High and low level ventilation openings in a structure shall be provided to ensure adequate combustion air, dilution of combustion products and venting of any gas escape. Ensure all ventilation openings are clear.

Figure 3: Appliance clearances from combustible material

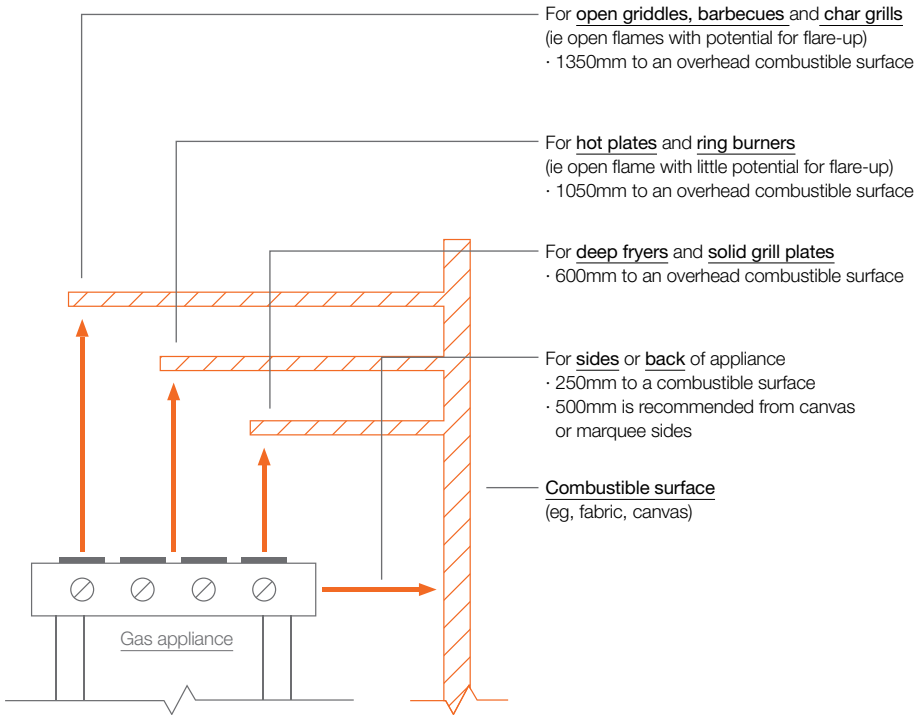

Cylinders and components

LP Gas delivery and storage

Consideration shall be given to the delivery and storage of LP Gas cylinders to the public event site. Personnel should be available to immediately distribute the cylinders if appropriate. This is the responsibility of the event organiser.

LP Gas cylinders shall be distributed to vendors. Care must be taken when handling cylinders so that they do not fall on one another or be otherwise subjected to shock.

Cylinder delivery (cylinder loading and unloading areas)

For delivery of cylinders, a clear access is to be provided. In many cases the gas supplier will unload the cylinders in an established location in order to facilitate the loading and unloading of cylinders from vehicles. This area shall be outside of any hazardous area around the cylinder filling point or cylinder storage area. Cylinders shall not remain in the loading and unloading area for longer than necessary. The cylinder loading and unloading area shall be clearly identified by markings or signs.

Cylinders stored in the open or within a building shall be located at least 1m horizontally away from an opening into, and shall be outside of, any building that is not used solely for storage, filling and handling of gas cylinders.

Cylinder storage

Cylinders that are stored but not connected for use, e.g. reserve or depleted cylinders, shall be stored safely in a compliant and designated area.

Site requirements include:

- » the location shall ensure that cylinders are not liable to physical damage, tampering, or excessive temperature rise
- » the standing area (other than a floor) shall be level, non-combustible and not prone to indentation such that water could accumulate or the cylinders could be dislodged and not resting on soil
- » buildings used for cylinder storage shall have non-combustible cladding for walls and roof and shall be ventilated
- » cylinders shall be kept in a location that does not hinder the escape of people, and is away from any combustible or waste materials.

A cylinder shall be separated at least 1m horizontally away from an opening into, and shall be outside of, any building that is not used solely for storage, filling and handling of gas cylinders.

The following additional requirements shall apply to the storage and handling of cylinders, including those that are empty but not gas freed:

- » the outlet valve shall be kept closed and it is recommended the valve opening be plugged

- » cylinders shall be handled carefully and not allowed to fall upon one another or be otherwise subjected to undue shock.
- » cylinders shall be secured to prevent movement or physical damage. Valves shall be safeguarded against physical damage
- » cylinders shall be placed so that the safety relief device will always be able to vent the vapour space. The relief vent shall be directed away from the appliance or combustible materials.

Cylinder stores shall be provided with adequate ventilation capable of diluting and removing any vapour or gas from the store.

Minimising LP Gas storage and usage

Wherever practicable, minimise the total number of cylinders in use. There shall be clear access to each cylinder at all times, sufficient to allow access to facilitate immediate closing of the cylinder valve in the event of a leak.

Cylinders in use

A cylinder in use is one that is connected to a system for the withdrawal of LP Gas.

All cylinders in use shall be located outdoors. The use of LP Gas cylinders indoors is not recommended. Cylinders that are installed outdoors shall be separated from public places and ignition sources. Refer to Table 1.

Decanting

Decanting is the practice of transferring LP Gas from one cylinder to another by using the difference in pressure between the two cylinders.

Decanting should not be carried out at public events.

Connection and changeover

The act of connecting the hose and regulator to the cylinder is a common risk. It is for this reason that special attention must be paid to ensure that:

- » an appropriate connection/changeover procedure is developed
- » the procedure includes leak testing with a soapy water solution
- » personnel are adequately instructed in the procedure
- » only persons competent and trained in the procedure are permitted to do that work.

Minimisation of changeovers

It is recommended that a schedule be developed whereby LP Gas cylinders are replaced at the end of each day when there are less people on site. Appliance hirers should be consulted to determine the appropriate length of time that an appliance can operate on any cylinder, and planning for replacement shall be based on this.

Movement of appliances or cylinders while connected or in operation

At no time while an appliance and cylinder are connected shall the appliance or cylinder be moved. Movement of either can cause stress on the joints and may damage the connection.

Always ensure that equipment is turned off and the cylinder valve is closed and the cylinder is disconnected from the appliance before moving either.

Turn off at the cylinder

If at any stage a potential leak is identified, it is important that the gas supply is isolated. This can best be achieved by closing the cylinder valve. Where cylinders are located externally, it is a requirement that each cylinder and the regulator is identified clearly against the appliance it supplies to make isolation of that appliance possible in an incident.

Cylinders shall be stored with all cylinder valves closed when not in use.

Stabilisation of cylinders

LP Gas cylinders connected to appliances shall be in an upright position in a well-ventilated area away from any flame, heat or other ignition sources. The relief vent shall be directed away from the appliance or combustible materials. The cylinder shall be secured in a stable position to minimise the chances of the cylinder being knocked over or the cylinder connection being placed under strain.

Cylinders shall be located so that they are not likely to be damaged or dislodged under normal circumstances of use. Cylinders should be installed on a firm, level, non-combustible base, and not resting on soil. The floor or base should be constructed so that water cannot accumulate within any enclosure or recess.

Stabilisation can be achieved by:

- » securing the cylinders to a permanent structure
- » securing larger cylinders with chains to a stake or star pickets
- » placing smaller cylinders inside an open crate (plastic crates are acceptable for public events). Crates made of wood, cardboard or other combustible materials are not acceptable. Care must be taken to ensure the valve and regulator are not obstructed or otherwise impacted by the crate
- » Fixed to a metal trolley that can be secured to prevent movement.

Distance from an ignition source

Cylinders in use shall be separated from ignition sources such as electrical equipment or other objects that may produce sparks, ignition or excessive heat. Figure 4 shows the clearance distances required from any exchange cylinder connection.

An appliance shall not be located within 1.5m of the cylinder. This requirement does not apply to the location of a flame or igniters of a gas appliance and its supplying cylinder where:

- » the cylinder capacity does not exceed 10kg (See Appendix B)
- » both the cylinder and the appliance are located outdoors, either as a fixed installation or as a portable or mobile appliance unit.
- » heat from the appliance will not cause the design temperature of the cylinder to be exceeded.

Walkways and egress routes

All walkways and egress routes should be a minimum of 1.2m wide.

Ventilation

All cylinders are to be provided with adequate ventilation.

Ventilation can be achieved in a number of ways and should ensure that there is no possibility for a build up of LP Gas vapours should any leakage occur.

Regulators

Installed appliances are required to be fitted with two stage regulators with over-pressure protection.

If an appliance is certified as portable, a single stage regulator will suffice. These are only acceptable for portable appliances supplied from a cylinder not exceeding 15kg and connected directly to a cylinder.

The cylinder regulator shall provide a maximum 3kPa outlet pressure with all appliances operating unless otherwise approved by ESV.

For installed appliances, the cylinder regulator shall be fixed to an adequate support independent of the cylinder and mounted with the diaphragm vertical and the vent pointing downwards. Regulators shall be connected to the cylinder by pipe work in accordance with AS/NZS 5601: 2013 Gas Installations.

The positioning of any regulator pressure relief shall be such that it points away from potential ignition sources.

Gas pressure regulators shall be mounted in a well-ventilated location so as not to obstruct the removal or replacement of cylinders and, if located externally, have the vent positioned to avoid blockage by contaminants.

Extract below from AS/NZS 5601 reproduced with permission from SAI Global under Licence 1408-c040.

Figure 4: Clearances around LP Gas cylinders

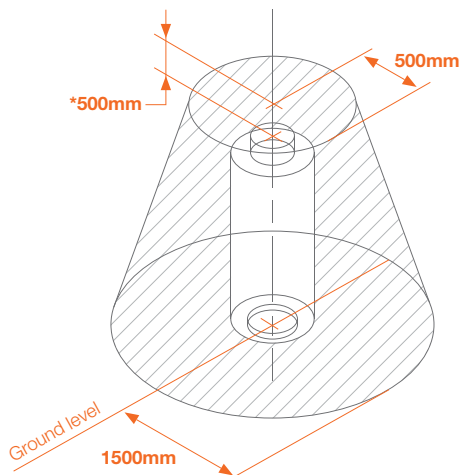

*This dimension is measured from the top of any cylinder valve

Gas hoses

The LP Gas supply hose should be connected to the back of the appliance wherever possible to prevent persons being tangled in or tripping over the hose.

Flexible hose length shall be kept as short as possible and not exceed a maximum length of 3m. The hose type shall suit the application and shall be of a continuous length (with no joints). An authorised person or component supplier can advise on this issue. Hoses should be regularly inspected and replaced if damaged or deteriorated in any way.

Setting up and dismantling

Permanent connections shall be made and unmade by an authorised person. A gasfitting notice shall be provided for this work by the authorised person. If piping is on the ground, it shall be protected from physical damage and trip hazards by having a protective cover over the pipe, or supported above ground by secure brackets or fixtures.

Gas limits

General

This section explains the quantity and size of cylinders permitted (in accordance with AS/NZS 1596) for the different structure types for public events. Refer to Table 1: LP Gas allowable quantities and cylinder sizes.

Permanent structure with permanent LP Gas installation

The gas installation to these buildings shall be carried out by an authorised person and shall comply with the Australian Standard: AS/NZS 5601: 2013 *Gas Installations*.

Table 1: LP Gas allowable quantities and cylinder sizes

Location	Quantity
<p>1. Temporary outdoor structures (e.g. marquees, tents, booths, or under awnings) are classed as outdoors for cylinder use and location</p> <p>(Note: Not classed as outdoors for appliance location)</p>	<p>Maximum total quantity—60kg Maximum cylinder size—15kg Totals include indoor and outdoor</p>
<p>2. Temporary outdoor structure Exceeding quantity and/or cylinder size in 1</p> <p>(marquees, tents, booths or under awnings are not classed as outdoors for cylinder use and location when exceeding limits in 1)</p>	<p>Maximum total quantity—270kg Maximum cylinder size—45kg No cylinders indoors All appliances connected from the one gas supply</p> <p>(i.e. If more than one cylinder, cylinders to be manifolded and supplied through the one regulator)</p> <p>Only to be installed by an authorised person where manifolded</p> <p>(These quantities can only be exceeded with the prior approval of ESV before the event)</p>
<p>3. Outdoors. No Structure Including open area under one roof with number of catering vendors (per each catering vendor stall)</p>	<p>Same as 1 and 2 above 15m gas free separation zone applies (see note below)</p>

Location	Quantity
<p>4. Temporary structure indoors A building with a roof and three or more walls</p>	<p>Maximum total quantity—10kg per 10m² of floor area, with a total quantity of 30kg</p> <p>Maximum cylinder size—15kg</p> <p>(If the quantity of gas or cylinder size is required to exceed the limit allowed, the cylinders shall be installed externally)</p>
<p>5. Permanent building with temporary gas installation</p> <p>(e.g. Container type building used for catering. Refer to 7 and 8 if assembly building)</p>	<p>Same as 1, 2 and 4 above depending on quantity of gas and whether indoors or outdoors.</p>
<p>6. Permanent buildings with permanent gas installation</p>	<p>Installation shall be installed by an authorised person to gas installation standard AS/NZS 5601:2013</p>
<p>7. Assembly buildings indoors</p>	<p>Maximum total quantity—45kg per 50m² floor area, up to a total quantity of 180kg</p> <p>Maximum cylinder size—45kg</p> <p>(If the quantity of gas or cylinder size is required to exceed the limit allowed, the cylinders shall be installed externally)</p>

Notes:

1. Gas quantities for cylinders are for generic cylinder sizes (not water capacity).
2. Groups of temporary structures in which gas is used.
Where temporary structures are grouped together, eg. a group of marquees, stalls or tents at a market, there shall be a maximum of 10 such structures using LP Gas in any such group. Groups of temporary structures using LP Gas shall be separated by at least 15m. The intervening space may be occupied by temporary structures in which no flammable gas or flammable liquids are kept. See Figure 5: Description of separation distances between groups.
3. Mobile catering vehicles are counted as a structure when determining the number of structures in a group.
4. For appliance location—A temporary structure is not defined as outdoors unless it complies with Figure 1: Examples of outdoor areas acceptable for the use of LP Gas.

Figure 5: Description of separation distances between groups

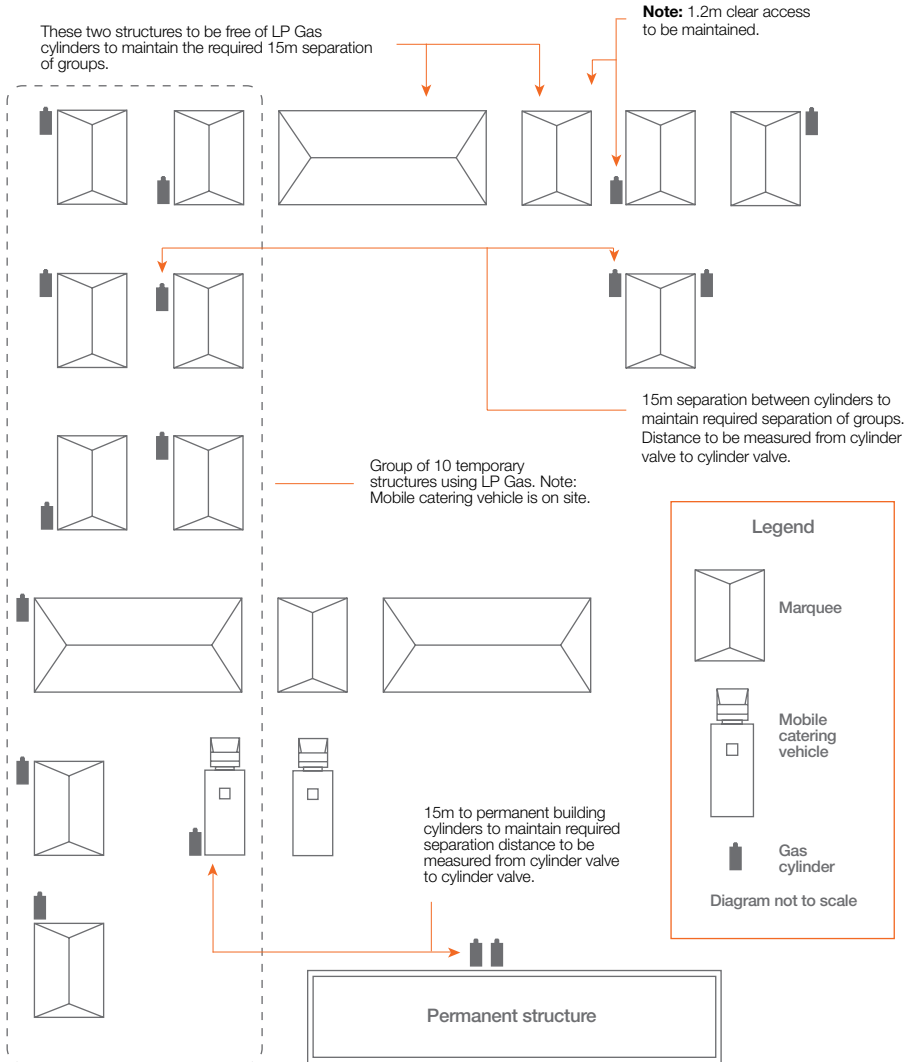

Appendix A— Example Gas safety check list

Gas safety check list

This check list is for use by catering vendors and authorised persons and should form a part of the catering vendor's safety plan.

Event name:

Vendor's name:

Stall number:

Mobile catering vehicle compliance number:

Vendor's signature:

Date:

Appliances	Yes	No	Action if No
Can proof of certification be provided for each appliance?	<input type="checkbox"/>	<input type="checkbox"/>	
Are all gas appliances in good working order?	<input type="checkbox"/>	<input type="checkbox"/>	
Are all appliance taps and knobs clearly marked and in good condition?	<input type="checkbox"/>	<input type="checkbox"/>	
Are all portable gas appliances correctly secured and placed on non-combustible surfaces?	<input type="checkbox"/>	<input type="checkbox"/>	
Are all portable and installed gas appliances adequately ventilated according to the requirements of this Code of Practice?	<input type="checkbox"/>	<input type="checkbox"/>	
Are all LP Gas cylinders in use located outside or in accordance with Table 1?	<input type="checkbox"/>	<input type="checkbox"/>	
Are appliances marked for use at pressures not exceeding 3kPa?	<input type="checkbox"/>	<input type="checkbox"/>	

Hoses and consumer piping	Yes	No	Action if No
Are all hoses in use in good condition?	<input type="checkbox"/>	<input type="checkbox"/>	
Are all hoses in use protected from accidental damage?	<input type="checkbox"/>	<input type="checkbox"/>	
Are all hoses in use less than 3m in length?	<input type="checkbox"/>	<input type="checkbox"/>	
Is the consumer piping in good condition?	<input type="checkbox"/>	<input type="checkbox"/>	
Regulators	Yes	No	Action if No
Are all regulators in good condition?	<input type="checkbox"/>	<input type="checkbox"/>	
Are all regulators in use protected from accidental damage?	<input type="checkbox"/>	<input type="checkbox"/>	
Cylinders	Yes	No	Action if No
Are all cylinders to be used in good condition?	<input type="checkbox"/>	<input type="checkbox"/>	
Have all cylinder connections been checked for leaks?	<input type="checkbox"/>	<input type="checkbox"/>	
Are all cylinders to be used stable and correctly secured?	<input type="checkbox"/>	<input type="checkbox"/>	
Are all cylinders to be used installed on a firm, level, non-combustible base, and not resting on soil?	<input type="checkbox"/>	<input type="checkbox"/>	
Is the floor or base on which cylinders are installed, constructed so that water cannot gather within any enclosure or recess?	<input type="checkbox"/>	<input type="checkbox"/>	
Are all cylinders to be used located away from flammable materials and ignition sources?	<input type="checkbox"/>	<input type="checkbox"/>	
Are walkways and egress routes clear of obstructions including LP Gas cylinders?	<input type="checkbox"/>	<input type="checkbox"/>	
Is the quantity of cylinders to be used correct for the structure type?	<input type="checkbox"/>	<input type="checkbox"/>	
Is the size of cylinders to be used appropriate for the structure type?	<input type="checkbox"/>	<input type="checkbox"/>	
Are all cylinders to be used within their test date period?	<input type="checkbox"/>	<input type="checkbox"/>	

Appendix B—Victorian Dangerous Goods (Storage and Handling) Regulations

The Victorian Dangerous Goods (Storage and Handling) Regulations 2012 set out specific duties for the storage and handling of dangerous goods. The regulations outline the duties that the occupier (the event organiser) must undertake, based on the types and quantities of dangerous goods being stored and handled.

Guidelines for complying with the regulations can be found in the Code of Practice for the storage and handling of dangerous goods 2013.

Considering LP Gas alone, the quantities of material on site are specified against the following requirements (all quantities in water capacity of all LP Gas vessels unless noted).

Placarding

Required if the on-site quantity exceeds 500L (approximately 250kg) of LP Gas

Placards provide visual warning to emergency services of the hazards associated with dangerous goods. The event organiser must ensure that the site is correctly placarded if dangerous goods stored exceed the quantity specified above. Required placards may include outer warning placards, dangerous goods class labels and bulk placards.

Preparation of a manifest

Required if the on-site quantity exceeds 5000L (approximately 2500kg) of LP Gas

A manifest provides emergency services with written information on the quantity, type and location of dangerous goods stored and handled on the site, to enable them to respond effectively and appropriately if called to an incident. The manifest must be kept on the premises in a place that is easily accessible to the emergency services as agreed with them.

Notification of storage and handling (Regulation 66)

Required if the on-site quantity exceeds 5000L (approximately 2500kg) of LP Gas

Sites that store and handle manifest quantities of dangerous goods are required to notify the WorkSafe Victoria of this fact; this includes events of a temporary nature. It should be noted that the notification should be submitted 30 days before the event to allow for sufficient processing time.

More information on these requirements can be obtained on the WorkSafe Victoria website worksafe.vic.gov.au or by contacting your local WorkSafe Victoria office on **1800 136 089**.

Emergency services written advice

Required if the on-site quantity exceeds 5000L (approximately 2500kg) of LP Gas

If quantities exceeding 5000L of LP Gas are likely to be present at your event, written advice must be obtained from appropriate emergency services in relation to fire protection and emergency planning. The event organiser requests the written advice of the emergency services authority in relation to the design of the fire protection system and emergency plan and must have regard to that written advice when establishing the system. (Note: the provision of written advice by the fire authorities will require some pre-event planning and time).

More information on these requirements can be obtained on the WorkSafe Victoria website [worksafe.vic.gov.au](https://www.worksafe.vic.gov.au) or by contacting your local WorkSafe Victoria office on [1800 136 089](tel:1800136089).

More information on these requirements can be obtained on the WorkSafe website: [worksafe.vic.gov.au](https://www.worksafe.vic.gov.au) or by contacting your local WorkSafe office on [1800 136 089](tel:1800136089).



**For further information go to
esv.vic.gov.au or phone **ESV's Gas
technical helpline on 1800 652 563.****

**esv.vic.gov.au
03 9203 9700
info@energysafe.vic.gov.au**

Energy Safe Victoria
Level 5, 4 Riverside Quay, Southbank VIC 3006
ISBN: 978-1-925838-43-5 (Online)

